

2

1

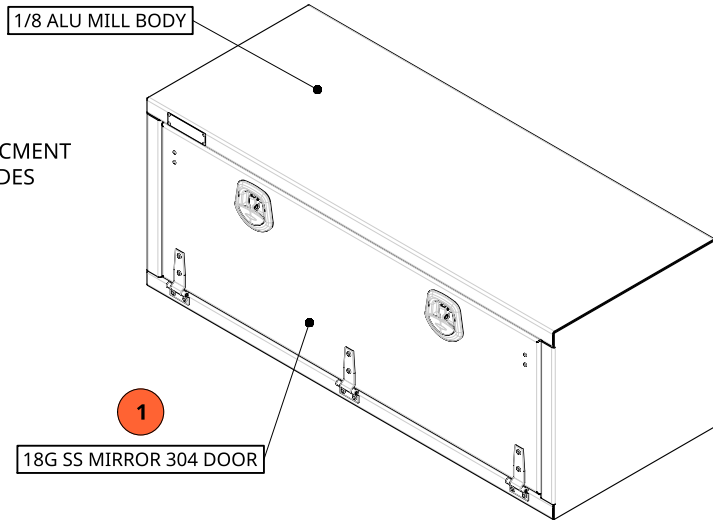

X2 DOOR CHAIN TO HOLD DOOR AT 90 DEG.

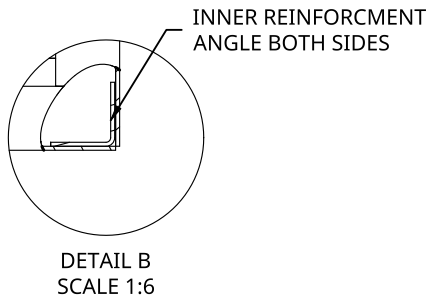
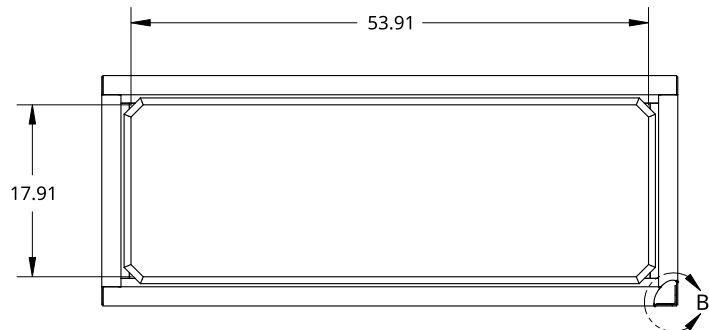
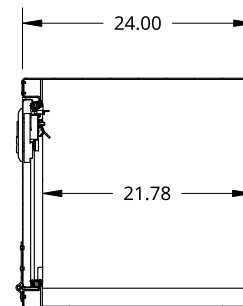
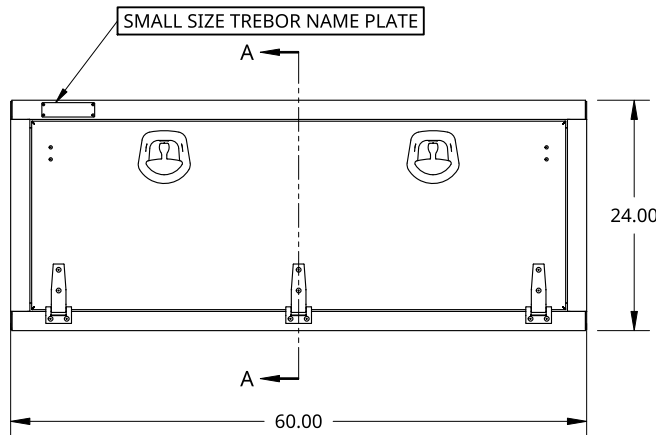
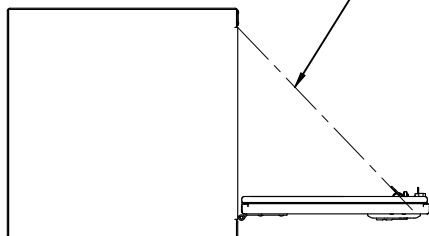

SECTION A - A

B

B

A

A

THIS DOCUMENT IS THE PROPERTY OF TREBOR MANUFACTURING. ANY UNAUTHORIZED REPRODUCTION WILL BE PROSECUTED TO THE FULL EXTENT OF THE LAW



PART NO. TRIDPLSS2460WT

REV. A

UNLESS OTHERWISE SPECIFIED, DIMENSIONS ARE IN INCHES

.XX = ±.1- ANGULAR = ±1°
.XXX = ±.015- FRACTIONAL = ±1/8
.XXXX = ±.005-

DRAWN BY	SHAWN CROCKER	08/03/2021
CHANGED BY	SHAWN CROCKER	03/17/2023

ONE DOOR RECESSED DOOR TOOL BOX - 24 X 24 X 60 - X2 WHALE TAILS - X3 HINGES - OPEN DOWN

THIRD ANGLE PROJECTION

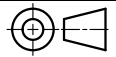

MATERIAL

MIXED MATERIAL

SIZE A DWG NO. D27931

REV. A

SCALE 1:20	WEIGHT 97.64 LB	SHEET 1 of 1
------------	-----------------	--------------

2

1