

2

1

RECESSED DOOR FRAME INNER GUSSET - 2IN TOP FRAME X 2IN SIDE FRAME

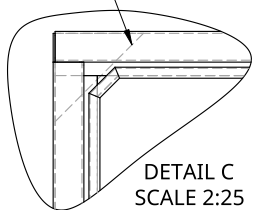

INNER REINFORCEMENT
ANGLE BOTH SIDES

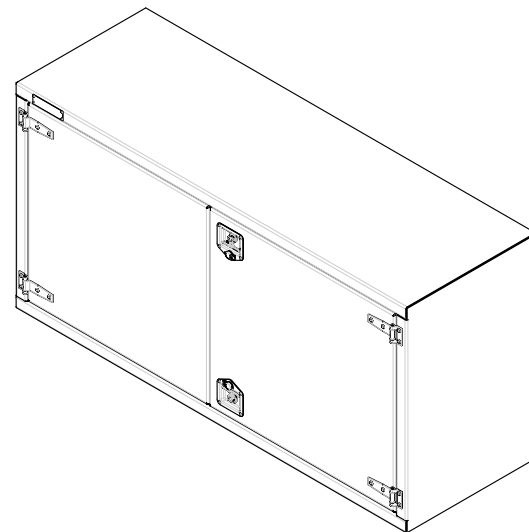
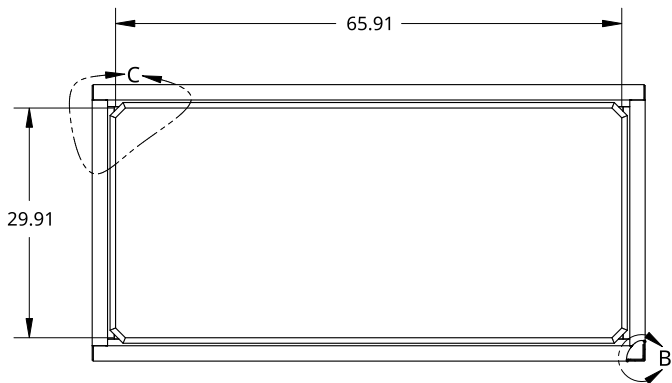
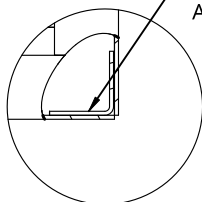

SMALL SIZE TREBOR NAME PLATE

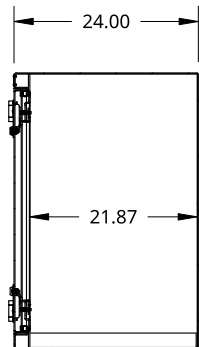
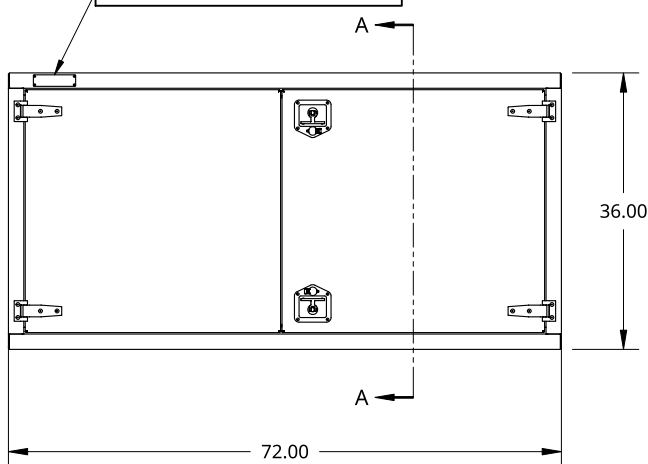

SECTION A - A

THIS DOCUMENT IS THE PROPERTY OF TREBOR
MANUFACTURING. ANY UNAUTHORIZED REPRODUCTION
WILL BE PROSECUTED TO THE FULL EXTENT OF THE LAW

UNLESS OTHERWISE SPECIFIED,
DIMENSIONS ARE IN INCHES

.XX = ±.1-
.XXX = ±.015- ANGULAR = ±1°
.XXXX = ±.005- FRACTIONAL = ±1/8

THIRD ANGLE PROJECTION

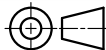

DRAWN BY	SHAWN CROCKER	09/29/2021
CHANGED BY	SHAWN CROCKER	02/28/2023

MATERIAL
1/8 ALU MILL

PART NO. TRPL3672

REV. A

TWO DOOR RECESSED DOOR TOOL BOX - 24 X 36 X 72 - T-HANDLE - OPEN RIGHT

SIZE A DWG NO. D25858

REV. A

SCALE 1:25	WEIGHT 147.99 LB	SHEET 1 of 1
------------	------------------	--------------

2

1

B

B

A

A